

Educating Attention from Neuroscience

Educar la atención desde la neurociencia

M. Rosario Rueda, Ángela Conejero, and Sonia Guerra

Departamento de Psicología Experimental y Centro de Investigación Mente,
Cerebro y Comportamiento (CIMCYC), Universidad de Granada, Spain

Abstract

Attention is a state of activation that allows individuals to select the information to be processed with priority and efficacy, as well as to control behaviour in a voluntary and conscious way. The development of attention provides the child with the necessary mechanisms to exert a greater and more effective regulation of thoughts, emotions, and actions. Attentional functions undergo an extraordinary development during the preschool years, although the developmental process continues throughout childhood and adolescence. The development of attention is supported by the maturation of frontoparietal brain structures. Research in the field of cognitive neuroscience has recently shown that the function of attention-related neural networks is influenced by both genetic factors and early experiences and education. Understanding cognitive processes and brain mechanisms underlying attention has the potential to help design educational strategies that optimize the development of this important capacity and promote children's socio-emotional adjustment and their ability to learn at school.

Keywords: attention, cognitive development, neuroscience, attention networks, executive control

Post to:

M. Rosario Rueda
Departamento de Psicología Experimental y Centro de Investigación Mente,
Cerebro y Comportamiento (CIMCYC)
Campus de Cartuja s/n, 18071 Granada, España
Email: rorueda@ugr.es
Study funded by the Ministry of Economy and Competitiveness of Spain
(project ref. PSI2014. 55833-P) and through Research Staff Training
Scholarships awarded to AC (ref. AC-2010-3525) and SGR (ref. BES-2012-
054072).

© 2016 PEL, <http://www.pensamientoeducativo.org> - <http://www.pel.cl>

ISSN: 0719-0409 DDI: 203.262, Santiago, Chile
doi: 10.7764/PEL.53.1.2016.15

Resumen

La atención es un estado de activación adecuado que permite a un individuo seleccionar la información que desea procesar con mayor prioridad y eficacia, así como controlar de forma voluntaria y consciente el comportamiento. El desarrollo de la atención dota al niño de los mecanismos necesarios para ejercer una mayor y más eficaz regulación de los pensamientos, emociones y acciones. Las funciones atencionales experimentan un enorme desarrollo durante los años preescolares, aunque el proceso de maduración continúa durante toda la infancia y adolescencia. Este desarrollo se sustenta en la maduración de estructuras cerebrales fundamentalmente frontoparietales. Estudios recientes en el campo de la neurociencia cognitiva revelan que el funcionamiento de estas redes neurales se ve afectado tanto por factores de tipo genético como por las experiencias tempranas y la educación. El conocimiento de los procesos cognitivos y mecanismos cerebrales que subyacen a la atención ayuda a elaborar estrategias educativas que optimizan el desarrollo de esta importante capacidad y promueven el ajuste socio-emocional de los niños y su capacidad de aprendizaje en el aula.

Palabras clave: atención, desarrollo cognitivo, neurociencia, redes atencionales, control ejecutivo

What is attention?

It is not easy to define attention. This is because *paying attention* involves a variety of aspects, all of them important in our everyday activities. For example, if somebody talks to me while I am trying to read, I am likely to understand either what I am being told or what I am reading. In this case, paying attention means choosing the stimulation source (what I am being told or what I read) that I want to prioritize. Information can also be selected as a reflex, that is, as a result of an external change in stimulation. Thus, if a sudden change in luminosity or sound occurs in the environment, it will grab our attention and orient us towards that position. However, paying attention is also necessary for controlling our actions in order to achieve our goals and not make mistakes. We often do things automatically. This is highly adaptive, because doing everything while paying full attention would be excessively slow and ineffective. But doing things automatically sometimes leads to mistakes. For example, if we are putting our kitchen utensils back in their place while doing something that demands a lot of our attention (such as talking on the phone or simply thinking about something that is worrying us), we may easily make a mistake and unwittingly put the sugar bowl in the fridge. This happens because attention is a limited resource, and when it is scarce, our behavior is left at the mercy of automatism. Paying attention, then, is a way of *controlling* action that is especially necessary when automatism does not lead us to doing what we want—something that is closely connected with *self-regulation* ability. Lastly, paying attention also requires an optimal activation level. We cannot pay attention with any efficacy if we are sleepy. Sometimes, certain events help us to be more alert. For example, the sound of a nearby ambulance will make us drive more attentively. Therefore, *preparation* and *activation* are aspects that are closely linked with the efficacy with that one pays attention. In short, acting attentively involves being in an adequate state of *activation* that allows us to *select* the information that we want to prioritize and process efficiently in order to *control* our behavior voluntarily and consciously.

Over the years, cognitive psychology has provided methods for measuring these functions with precision. In the second half of the 20th century, taking advantage of the development of information technology, computer tasks were designed in order to measure cognitive processes with great precision. Traditionally, warning signals (e.g. auditory or visual preparation signals) have been used to measure the effect of activation or alertness, while orientation has been measured with visual signals that appear in specific locations of the screen before the appearance of the stimuli to which the subject must respond. Alerting cues do not guide a subject's attention towards a specific position, but they do have a preparation effect. Generally, orienting cues are of two types: (a) valid, when they gear a person's attention toward the position on the screen where the stimulus to which he/she must respond is to appear, or (b) invalid, when they direct a person's attention to an incorrect position from which he/she will need to disengage and later reorient his/her attention when the target stimulus appears. On the other hand, the tasks that are most frequently used to measure attentional conflict, also known as *executive attention*, are called *conflict tasks*. In general, these tasks require that the subject select a non-dominant response in the presence of stimuli

suggesting another response that is dominant but incorrect. The suggested but incorrect response induces a conflict that must be solved in order to choose the correct response. The conflict between stimuli or responses can be provoked in various ways. One way of inducing a conflict is to provide distracting information that is irrelevant for the task but that suggests responses that are incompatible with the correct one. This is the case of flanker tasks (Eriksen & Eriksen, 1974). Usually, the subject is asked to respond to a stimulus displayed in the center of the screen (for example, stating in which direction the fish is pointing toward in the task illustrated in Figure 1) while stimuli are shown on the sides that suggest either the same response (congruent trials) or the opposite response (incongruent trials). Subtracting response time and/or percentage of errors (as dependent variables) between congruent and incongruent trials provides an index of interference that indicates the speed or precision cost resulting from the need to solve the conflict induced by distracting flankers.

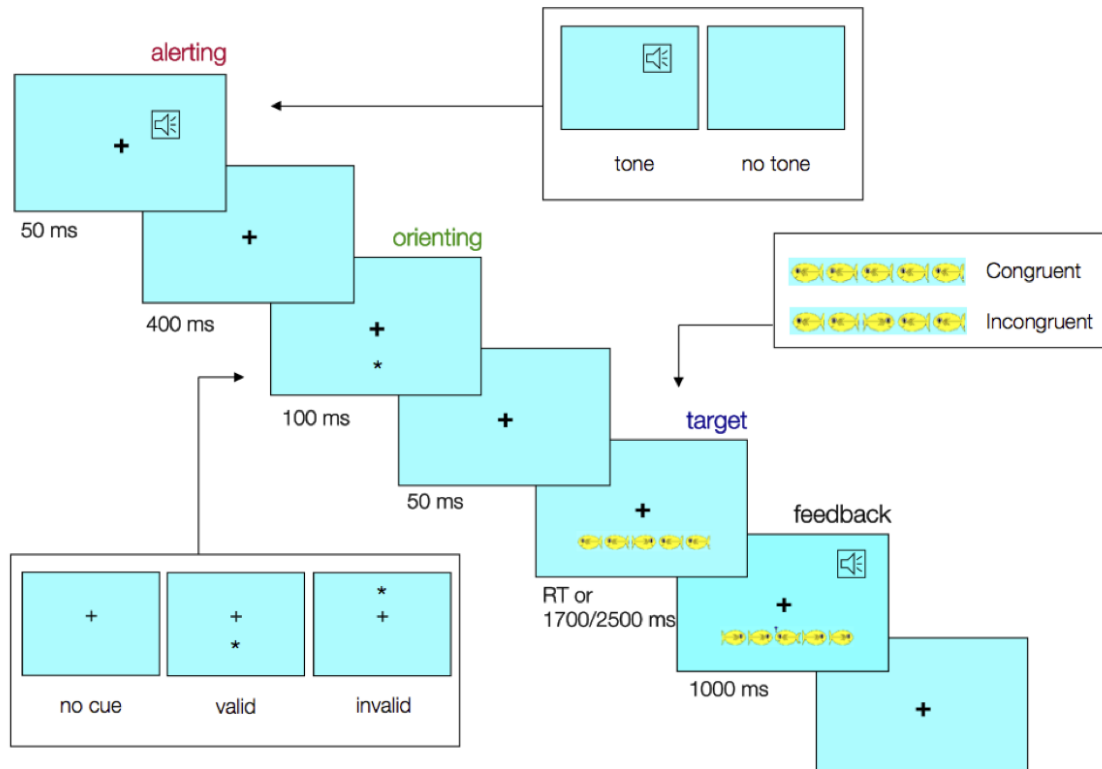

Figure 1. Schematic representation of the child version of the Attention Network Task.

Incorporating the logic of these different procedures into a single task, Fan, McCandliss, Sommer, Raz, and Posner (2002) developed the so-called Attention Network Task (ANT), that was subsequently adapted for children (Rueda et al., 2004; see Figure 1). In this task, subjects are asked to state the direction toward which the central stimulus (an arrow in the adult version and a fish in the child version) is pointing by pressing a key, a simple enough task for children aged approximately 3-4 and older. The ANT yields scores for each of the attentional functions described above, because it contrasts execution in terms of both response speed and precision in conditions with an alerting cue *vs* without an alerting cue (alerting score), valid *vs* invalid orientation (orienting score), and in conditions with congruent flankers *vs* incongruent flankers (executive attention score).

Neuroanatomy of attention

The brain is the organ of cognition, and so it is greatly useful to study its functioning and development in order to understand the functioning and development of cognitive functions. Over the last decades, the technology that makes it possible to examine the functioning of the brain in vivo, while people

perform tasks intended to measure cognitive functions, has developed greatly. With these techniques, we can determine the anatomy of these functions and learn about the biological mechanisms that sustain them.

It is relevant to differentiate the three aspects of attention (activation, selection, and control) that we have just defined, because each of them is associated with the functioning of different brain regions. Figure 2 provides an overview of the anatomy of each attention network (regions involved in each attentional function), along with the activation time and the neurotransmitters that modulate the activation of each of them. This figure presents information about the cerebral basis of attentional functions obtained using several methodologies: electroencephalography (EEG), functional magnetic resonance imaging (fMRI), and pharmacological manipulations. The activation time data show that the brain responds very early (at around 100 milliseconds) to alerting and orienting cues. Valid orienting cues strengthen the response of occipito-parietal regions involved in perceptual processing, whereas invalid cues produce an activation in parietal and frontal regions involved in shifting attention voluntarily from one position to another. The activation of these regions is modulated by the levels of acetylcholine in the brain. Preparation cues are processed early on in subcortical structures, such as the *locus coeruleus* in the brain stem, the main source of norepinephrine for the brain cortex. These cues produce a sustained signal called CNV (Contingent Negative Variation), generated by frontal lobe structures associated with sustained attention. Lastly, the executive attention network has a main node in the anterior part of the cingulate gyrus, as well as in the basal ganglia and other frontoparietal regions. Conditions involving a heavier attentional control load (e. g. incongruent flankers) consistently produce a modulation in the amplitude of the EEG signal at around 200-300 milliseconds, a signal that has been linked with increased activation in the anterior cingulate gyrus and is associated with the detection of conflicts and their resolution. Dopamine and serotonin levels in these regions modulate the activation of this network (see Rueda, Pozuelos, & C6mbita, 2015, for a more thorough review of the brain mechanisms associated with attention networks).



Network	Contrast	Timing (Abundis-Gutiérrez et al. 2014)	Anatomy (Fan et al., 2005)	Chemistry (Marrocco & Davidson, 1998)
Alerting	No Cue - Cue 			Norepinephrine 
Orienting	Invalid - Valid 			Acetylcholine 
Executive	Incongruent - congruent 			Dopamine, Serotonin 

Figure 2. Representation of different levels of knowledge about attentional networks. The contrast shows the experimental conditions that are frequently used to measure each of the functions of attention. The activation time column shows evoked potentials associated with such conditions, while the anatomy condition displays the brain structures activated when contrasting these conditions. Finally, the right-hand side column shows the neurotransmitters that have been associated with each attentional function.

Differential anatomy indicates that the different aspects of attention are associated with neurotransmitters (chemical substances that neurons use to communicate with one another) that tend to act in these regions, and also with the genes that determine, at least partly, neurotransmitter levels in the brain. In addition, differential anatomy provides an explanation to the fact that the activation, selection, and control capabilities have different courses of development in infancy and adolescence.

Development of attention

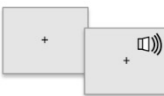
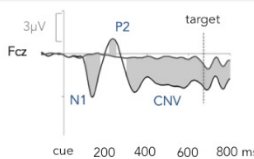
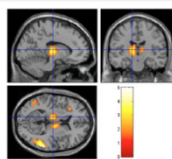
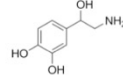
Out of all attention networks, the alerting network appears to have the fastest development. At around 12 weeks of life it is already possible to observe a change in babies' ability to remain in a state of alert. While newborn babies are rarely able to remain awake and spend most of their time sleeping, they become more active around this age, and the percentage of hours per day during which they can stay awake increases significantly (Colombo & Horowitz, 1987). Nevertheless, their ability to sustain their attention is still dependent on external sensory stimulation, provided to a large degree by their caregivers. For this reason, at 3 months of age, attention is still regarded as essentially *reactive*, since the alerting network responds mostly to exogenous events or uses low-level arousal mechanisms (Rueda & Posner, 2013). Between 3 months and one year of age, changes are observed in children's ability to sustain attention, depending on the complexity of the stimulus. As children grow up they lose interest more quickly when exposed to simple stimuli, such as a set of static geometrical shapes or faces; however, the time during which they are able to pay attention to more complex stimulation, such as a dynamic scene from a television program for children, increases (Courage, Reynolds, & Richards 2006). Between the first and the second year of life, the child's ability to sustain attention continues to increase. So, during a free play situation, one-year-old children experience a decrease in the attention they pay to toys during the time they spend playing, a reduction that is not observed in two-year-olds (Ruff & Lawson, 1990).

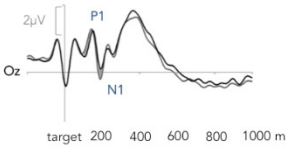
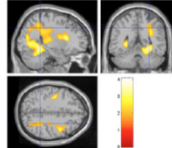
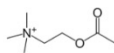
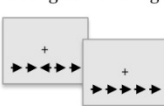
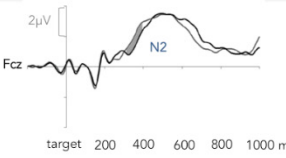
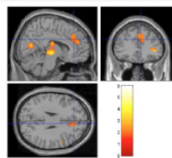
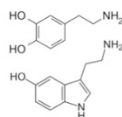
Later on, when children acquire the ability to understand and follow instructions, we can design tasks to observe the development of the mechanisms needed to maintain an alert state endogenously. *Continuous execution tasks* are a well-known and widely used type of task. In them, we ask the children to provide a certain response (e. g., pressing a key every time the letter *a* appears on the screen) to a series of stimuli (e.g. different letters) that are shown over a relatively long period. Children's ability to maintain their alert state during the task improves considerably in preschool years (Danis, Pecheux, Lefevre, Bourdais, & Serres-Ruel, 2008), and continues to develop until reaching near-adult execution levels at around 13 years of age (Lin, Hsiao, & Chen, 1999).

On the other hand, the attention orienting network develops intensely between 3 and 4 months of age. Beforehand, babies experience what has been labeled *obligatory attention*. This phenomenon consists in finding great difficulty to disengage one's gaze from an object in order to shift one's attention toward a different object (Hood, 1995). Between 3-4 months of age, babies are already capable of disengaging their attention from stimuli to which they have become accustomed (Johnson, Posner, & Rothbart, 1991). In addition, from this age onward, babies can orient themselves more quickly toward a stimulus when it is preceded by a cue indicating where it will appear, just like adults (Johnson, 1994; Johnson & Tucker, 1996). However, babies' ability to disengage their attention voluntarily (that is, to orient their attention endogenously instead of reacting automatically to external stimulation) only appears at around 18 months of age (Ruff & Rothbart, 1996). During preschool years and throughout the rest of infancy, the speed with which children are able to redirect their attention in response to orienting cues continues to increase (Schul, Townsend, & Stiles, 2003). Also, their ability to direct their attention voluntarily improves between 6 and 14 years of age. From age 6 onward, children benefit from longer intervals between the orienting cue and the appearance of the stimulus to which they must respond, because they can use that time to direct their attention voluntarily towards the required spot (Wainwright & Bryson, 2005).

The development of the executive attention network in the first months of life is partly sustained by attention orienting mechanisms, when the first endogenous control mechanisms emerge. The first signs of incipient attentional control appear at 6 months of age. At this age, babies are able to inhibit attention to irrelevant stimuli that can distract them from more interesting things about which they could learn (Holmboe, Fearon, Csibra, Tucker, & Johnson, 2008). As frontal brain structures start to mature (especially the anterior cingulate cortex and its connections with other structures), children begin to display more flexible and adapted behavior. There is evidence that the circuits of the executive attention network start becoming functional toward the end of the first year of life (Diamond, 1990, 2006). For example, Berger, Tzur, and Posner (2006) showed that, around 9 months of age, babies display cerebral activation associated with midline frontal structures when they observe arithmetic errors (e. g. a doll is shown, then hidden behind a screen, and later another one is added, but when the screen is removed, only one doll appears instead of two). This type of brain response to error is also observed in adults when they observe or make a mistake, and is associated with conflict detection (in this case, between expectations and actual events), an element that characterizes the executive attention network.

Between 2 and three years of age, it is also possible to observe an improvement in children's ability to select between different competing responses. In a spatial conflict task in which children must select the house of a certain animal out of two houses on each side of the screen, from 30 months of age onward children are better at solving the conflict generated by the situation in which the animal appears over the house opposite the correct one. However, even though they are able to inhibit the automatic response of selecting the house right below the animal in order to choose the one on the other side of the screen and also make fewer mistakes, they continue responding more slowly. Reaction time (RT) provides us with a conflict measure that can be used to examine the efficacy of the functioning of executive attention. Thus, greater conflict effects (a larger difference in RT between conditions without and with spatial conflict) are indicative of lower executive attention efficacy (Gerardi-Caulton, 2000). Judging from the data obtained from such tasks, it is only towards the end of infancy that the executive attention network reaches a degree of efficacy approaching that of adults (Pozuelos, Paz-Alonso, Castillo, Fuentes, & Rueda, 2014), that makes it the attention network with the most belated and prolonged development.

Using the child version of the ANT task presented in the previous section (Figure 1), several studies have traced the development of the three attention networks. Rueda et al. (2004), in their study with children aged 6-10, revealed that each network followed a different course of development, with alertness scores remaining stable during this period and with no differences in the orienting network either (that indicated an earlier maturation of these networks), but with a considerable increase in the efficiency of the executive attention network between 6 and 7 years of age and no major changes afterward. A later study that included invalid cues in order to study the development of the orienting network revealed that, even though the development pattern of the alerting and executive attention networks was the same as the one found by Rueda et al. (2004), the orienting network continued to develop during this period (Pozuelos et al., 2014). Abundis-Guitierrez, Checa, Castellanos, and Rueda (2014), also using the child ANT, analyzed the neural mechanisms associated with the development of each of the networks. In order to do this, they recorded brain activity using electroencephalography. The cerebral responses associated with the processing of the stimuli (or evoked potentials) can differ in terms of latency (that is, the time it takes for brain activation to appear), amplitude (the magnitude of the activation), or duration (the time during which the activation remains). These researchers discovered that the differences due to age were more evident in early evoked potentials, that is, in the first stages of stimulus processing (Figure 2). Under 10 years of age, alerting cues (in this task, a tone preceding the stimulus) were deficiently processed. While adults and children that age displayed a very early brain response after the alerting cue, associated with the individual's preparation for processing the stimuli coming afterward (N1), younger children did not display this type of cerebral activation in connection with the alerting cue. Regarding the orienting network, the authors discovered that children under 9 years of age needed to activate it to a greater extent in order to make use of the cues that helped them to orient their attention. This was again observed in earlier evoked potentials, with a neural activation that displayed greater amplitude and persisted for a longer time in younger children, a situation that has been linked to the need of exerting more cognitive effort. Finally, with respect to the executive attention network, the evoked potentials associated with conflict processing (N2) appear later in children than in adults. That is, the brain of younger people takes a little longer to respond when it has to process situations requiring executive attention, with latency decreasing with age.

Thus, from an early point in development, it is possible to see how the brain circuits corresponding to each of these networks begin preparing to take up certain functions. This does not mean that we do not continue observing developmental changes later on. On the contrary: the development of networks persists throughout infancy and lasts until adulthood. All in all, from the first stages of development onward, we can already note the presence of differences between people regarding the efficiency of their attention. In the following section, we will present evidence about the factors that constitute a source of variability in attentional capacity during human development, referring to the possible influence of both genetic and environmental variables.

Individual differences in attentional abilities

Genetic factors

One of the first steps for studying the influence of genetic factors on attentional capacity is to examine their inheritability through twin studies. One of these studies compared the execution of the ANT task by monozygotic twins (identical twins, who share 100% of their genes) and dizygotic twins (commonly known as *fraternal twins*, who share no more genes than any other pair of brothers). It was discovered that, in monozygotic twins, the concordance between their alerting and executive network scores (but not their orienting network scores) was greater than in the case of dizygotic twins (Fan, Wu, Fossella, & Posner, 2001). This suggests that the alerting and executive attention networks, but not the orienting network, have a major hereditary component.

Another part of the research has focused on identifying genes that may be linked to the efficiency of each attention network. In order to do this, one way of reducing the list of genes with a potential influence on the functioning of each attention network is to consider the genes whose polymorphic variations modulate the neurotransmitter levels in the brain associated with each attention network. The neurotransmitters associated with each attention network are shown in Figure 2. In this way, a number of studies have examined the relationship between genes linked to dopamine levels in the brain and the functioning of the executive attention network. These genes have shown that polymorphic variations in genes such as DAT1, DRD4, and COMT, that influence the amount of dopamine available in the prefrontal cortex, explain at least partly individual differences in executive attention capacity as measured through scores in experimental tasks (Congdon, Lesch, & Canli, 2008), and also account for variations in brain functioning (Congdon, Constable, Lesch, & Canli, 2009; Mueller, Makeig, Stemmler, Hennig, & Wacker, 2011). Likewise, a significant relationship has been established between variations in genes that regulate the function of cholinergic receptors, such as CHRNA4, and the execution of selective attention tasks (Greenwood, Parasuraman, & Espeseth, 2012). In addition, cholinergic and dopaminergic genetic markers have been linked to individual differences in temperamental traits associated with executive control and self-regulation (Posner, Rothbart, & Sheese, 2007).

Environmental factors

Even though genetic inheritance has been shown to play a relevant role in the development of attention, which of environmental and educational variables is no less important. When we mention environmental factors, we are also including those elements in our environment which pertain to socioeconomic status, such as parental education, occupation, or family income.

Several studies have shown that having low SES or living in poverty relates to poorer performance in cognitive tasks, especially if these tasks involve executive attention (Duncan, Yeung, Brooks-Gunn, & Smith, 1998; Noble, McCandliss, & Farah, 2007). In a study with children aged 6-7 in which the child version of the ANT was used, it was revealed that low-SES children display less efficiency in the alerting and executive attention networks than children from higher SES families, although no differences in the orienting network were observed (Mezzacappa, 2004). Other studies, however, have revealed differences in children's attentional selection capacity in connection with their caregivers' educational level. In this regard, Stevens, Lauinger, and Neville (2009), using a dichotic listening task that consists in paying attention to what is heard in one ear and ignoring what is heard simultaneously in the other, showed that children from families with a lower educational level experienced more difficulties when attempting to ignore the information presented in the ignored channel: the difference in their cerebral activation for the information they ignored and that to which they paid attention was smaller than in the case of children from families with a higher educational level (Stevens et al., 2009).

It must be pointed out that effects of the environment on the development of executive attention are observable from an early age. Using an A-not-B task, it has been shown that babies raised in low-SES families, at around one year of age, engage in more instances of perseverance, going back to a location where a toy was previously hidden even though it is no longer there—a behavior indicative of lower attentional flexibility (Lipina, Martelli, Vuelta, & Colombo, 2005).

The effect of SES has not only been observed in connection with behavioral measures; also, researchers have proved how it affects the development of various brain structures. More concretely, lower SES has been linked to a lower volume of prefrontal cortex structures belonging to the executive attention network (Clearfield & Jedd, 2013; Lawson, Duda, Avants, Wu, & Farah, 2013).

Another aspect that has been linked with the efficiency of the executive attention network is the way in which parent-child relationships are established, including the rearing practices employed by parents, the type of attachment developed by children toward their caregivers, the parental style adopted, and the caregiver's sensitivity to the child's needs. It has been observed that when caregivers provide support aimed at promoting the child's autonomy (for example, teaching him/her strategies that suit his/her competence level to solve problems and providing chances for him/her to use them), the child performs better in tasks requiring executive attention (Bernier, Carlson, & Whipple, 2010).

All this evidence shows that experience can modulate the development of attention. This suggests that the brain, and thus also cognitive abilities, has a great plastic capacity, and if we provide the right experiences we can promote the optimal development of mental skills. For this reason, interventions seeking to train cognitive functions constitute a good tool not only for improving children's abilities and academic performance, but also for preventing attentional alterations. As we will show later on in the text, knowing the cerebral mechanisms that underlie the development of attention will help us to know and test the effects of intervention programs and to improve their design.

Attention in school

The development of attentional control in infancy and adolescence is closely linked with factors associated with education, such as socio-emotional adjustment and academic performance (Rueda, Checa, & Rothbart, 2010). As self-regulation systems develop, children display a growing ability to control reactivity and adapt to norms or goals, flexibly tackle situations that they fear, or inhibit actions that they desire to execute (Derryberry & Rothbart, 1997; Rothbart & Derryberry, 1981). This ability to regulate attention through voluntary control has been linked with the empathy that children show toward others and their ability to avoid lying or deceiving others, and high indices of voluntary control have been linked to a lower number of antisocial behaviors in adolescents (Rothbart, 2011). In general, low or moderate temperamental reactivity, both positive (impulsiveness and activity level) and negative (fear, anger, etc.), combined with good self-regulation skills, provides better possibilities for adequate socialization and academic success in children.

It is probable that self-regulation mechanisms related with the activation of the executive attention network play a part in the relationship between low voluntary control and deficient socialization. In a study conducted with a task comprising flankers and evoked potentials, it was demonstrated that children who make more mistakes in incongruent trials display lower amplitude in the ERN component (Error-Related Negativity), that appears after making a mistake and that is linked with the activation of the executive attention network. On the other hand, ERN amplitude is associated with social behavior. After administering a self-report personality questionnaire, it was observed that children with lower levels of social sensitivity display less amplitude in the ERN component (Santesso, Segalowitz, & Schmidt, 2005). This data set indicates that children with poorer socialization have more difficulties for experiencing or appreciating the emotional meaning of mistakes due to the less efficient responses of their executive attention network.

Attention and self-regulation skills are essential for school readiness due to their usefulness for predicting later performance in school (Duncan et al., 2007). In a study conducted with 12-year-old children, it was observed that those who obtained better grades and who also displayed better school performance were those who showed better social adjustment (Checa, Rodriguez-Bailon, & Rueda, 2008). Some authors have proposed that the main factor for fostering school competences are positive social relationships at school (Mashburn & Pianta, 2006). However, the data provided by Checa, Rodriguez-Bailon, and Rueda (2008) show that the positive relationship between socialization and relevant abilities for academic success, such as following rules and frustration tolerance, is mediated by children's attentional control and regulation ability.

In the cognitive literature, a strong association has been reported between executive attention and executive functions (EF). This term refers to a family of cognitive processes associated with the voluntary and conscious control and regulation of thoughts and actions. It is a widely accepted idea that EFs can be divided into three central domains: working memory, inhibitory control, and cognitive flexibility (Diamond, 2013; Miyake et al., 2000). In this regard, the concept of executive attention overlaps to a large extent with the EFs of inhibitory control and cognitive flexibility.

Executive attention and EFs are the basis of fluid intelligence, defined as a set of higher order skills such as reasoning, problem-solving, and planning. These skills are greatly relevant in any context of a child's life, but especially in school, where they must continually tackle novel learning situations that require organized, strategic, and efficient behavior (Anderson, 2002).

Longitudinal research suggests that executive attention is an integral component of academic achievement, to which it also contributes (Bull, Espy, & Wiebe, 2008; Rueda et al., 2010). Some studies indicate that working memory and inhibitory control capacity in preschool predicts Mathematics grades at the end of first grade in elementary school (Monette, Bigras, & Guay, 2011). As we pointed out at the beginning of the article, the first years of primary education constitute a critical period for the development of cognitive flexibility, with data linking cognitive flexibility with school readiness and academic performance (Yeniad, Malda, Mesman, van IJzendoorn, & Pieper, 2013). This relationship is also observed with regard to the activation of the executive attention network. In a study with evoked potentials, Checa et al. (2008) observed that the interference effect of flankers on the N2 component predicts Mathematics grades in children aged 12.

All this evidence stresses the importance of promoting cognitive skills and effective executive attention mechanisms during children's development, including interference inhibition, conflict-solving, cognitive flexibility, and working memory. Intervention through training programs focused on several cognitive and emotional processes in a period as important as infancy can have a direct positive impact on the brain networks that sustain executive attention and regulation at both a cognitive and an emotional level, thus fostering improvements in school performance, academic competence, socio-emotional skills, and socialization.

Attention training

The brain's ability to change in response to experience (i.e. plasticity) provides a good opportunity to conduct interventions during development aimed at influencing the cognitive skills known to be crucial for school learning. For this reason, a growing number of studies have sought to shed light on the effect of a number of training programs on cognitive performance and the brain structures that sustain them.

Training involves practicing with one or several exercises, generally using a computer, that are specifically designed to stimulate specific cognitive skills. The main tool of these process-centric training programs are exercises based on principles derived from classic Cognitive Psychology tasks. The idea is that the repeated practice of the exercise, along with a gradual increase in difficulty, will strengthen the cognitive processes marshaled to perform the exercise correctly. Figure 3 shows some of the exercises used to train EFs. In the *Portraits* exercise, the participants must choose the portrait at the bottom of the screen that is exactly the same as the sample. The task becomes harder in later levels in order to foster attentional focusing and perceptual discrimination. At higher difficulty levels, the sample portrait disappears and must be kept in memory in order to perform the comparison. The *Farmer* exercise trains inhibitory control. In this game, the participant must first click on the haystack to select it; if what is shown afterward is a sheep, he/she will have to select it quickly to make it enter the fenced area. On the contrary, if what appears behind the haystack is a wolf, the participant must inhibit the response and wait for the wolf to disappear. In the stop signal trials, the wolf appears disguised as a sheep and loses its mask after a brief interval. In this case, the demand for inhibitory control is greater. In the *Shapes* exercise, the participant must press the buttons on the sides to indicate which forms are present in the center. He/she must remember what buttons he/she has already pressed to avoid giving repeated responses that are considered incorrect. At higher difficulty levels, the shapes are abstract and drawn with dotted lines. Finally, *Sky or Ground* is an exercise intended to train executive attention. It consists in categorizing the central figure depending on whether it normally travels through the sky (by pressing the clouds button) or on the ground (by pressing

the trees button). In inverted categorization levels, signaled by an inverted face, the participants must classify the elements that move in the sky with the ground button and vice-versa.

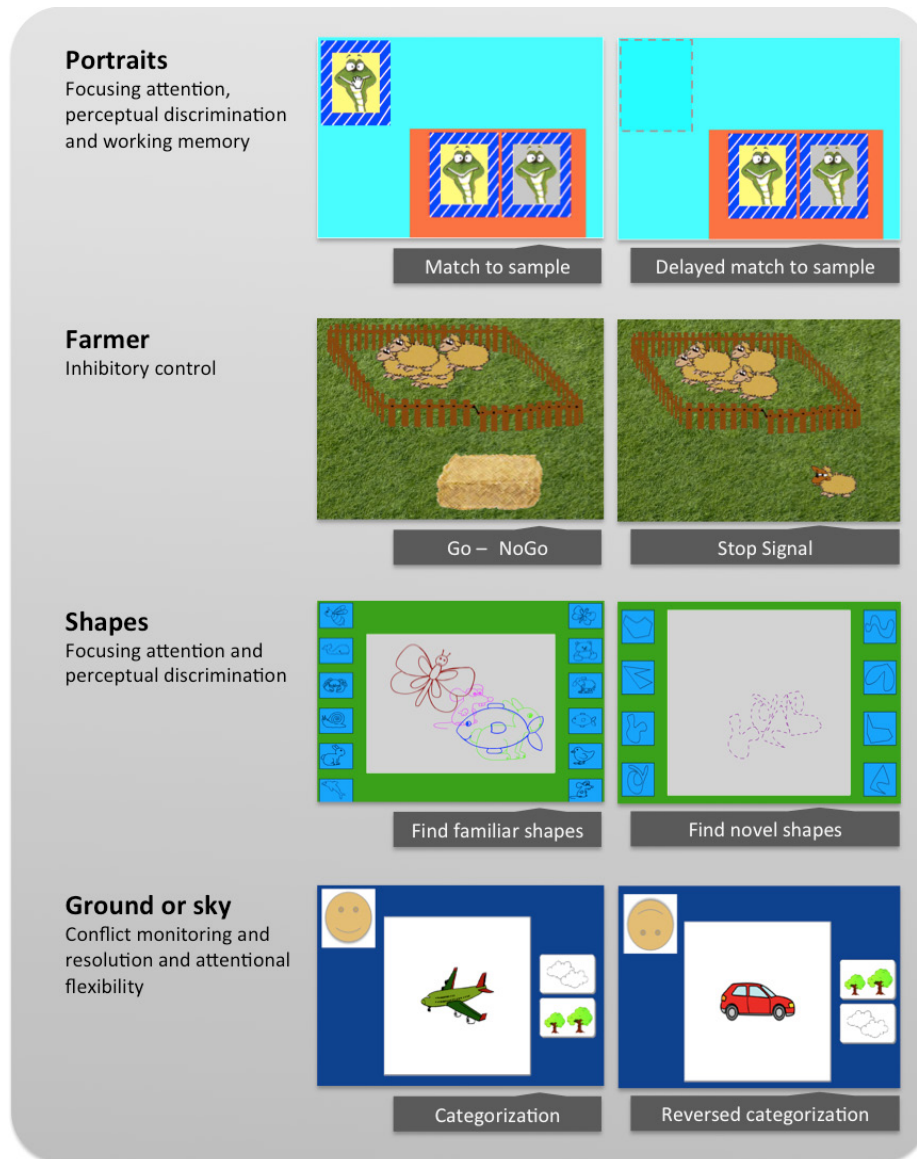

Figure 3. Sample of the attentional training exercises used in Rueda, Checa, and C3mbita (2012).

A growing number of studies show that the implementation of such training programs improves cognitive skills, even producing a beneficial effect on the brain networks that sustain them. We can highlight some studies that use this type of interventions in training programs mainly focused on executive attention (Rueda, Checa, & C3mbita, 2012; Rueda, Rothbart, McCandliss, Saccomanno, & Posner, 2005), working memory (Jaeggi, Buschkuohl, Jonides, & Shah, 2011; Thorell, Lindqvist, Nutley, Bohlin, & Klingberg, 2009), inhibitory control (Millner, Jaroszewski, Chamarthi, & Pizzagalli, 2012), and cognitive flexibility (Karbach & Kray, 2009; Kray, Karbach, Haenig, & Freitag, 2012).

In order to understand how cognitive training influences brain plasticity, some studies have incorporated neuroimaging techniques. Rueda, Rothbart, McCandliss, Saccomanno, and Posner (2005) tried used EEG to study the influence of training on the efficiency of the executive attention network. To do this, they worked with a sample of children aged 4-6 in a computer-based training program during 5 sessions.

In this study, the participants completed the ANT task before and after a cognitive training program while their brain activation was recorded using EEG. The cerebral activation data reveal a beneficial effect of training on the executive network of the children included in the experimental group compared with those in the control group. Concretely, the trained children display a reduction in the activation latency associated with midline frontal structures. In addition, the training produces a change in the topographic maps: an earlier and more posterior activation appear, an activation pattern closer to that of adults working on the same task (Figure 4). These results suggest that cognitive training modifies the brain mechanisms of conflict-solving, bringing them closer to a more mature pattern. In addition, the beneficial effect of attentional training also impacts untrained measures, such as fluid intelligence.

In a later study with 5-year-old children, the training program was optimized by increasing the number of exercises and training sessions. This time, the results obtained replicate the benefits of training in terms of both brain activation and fluid intelligence. The trained children displayed a faster and more efficient activation in the brain circuits involved in executive attention (Rueda et al., 2012). In addition, a two-month follow-up was conducted after the end of the intervention, and it was observed that the trained children continued to display an advantage in terms of brain activation time compared with the untrained children.

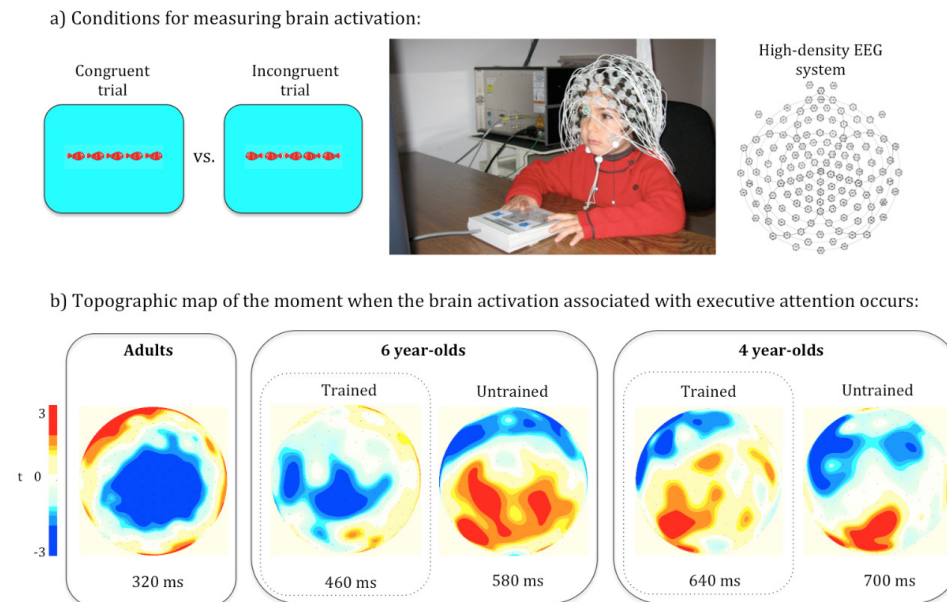

Figure 4. Representation of the experimental conditions of the flanker task with which executive attention is measured and execution of the task by a 5-year-old girl (a). Effect of attentional training on the activation latency of frontal structures. The time shown under each topographic map indicates the moment when a greater activation amplitude is observed in frontal channels during a period of intense engagement of executive attention. The datum shows that activation occurs more quickly in the trained groups (b). The data used to prepare the figure were extracted from Rueda et al. (2005).

Using a different technique, Jolles, Van Buchem, Rombouts, and Crone (2012) studied the effects of working memory training on brain functioning. In order to do this, they trained 12-year-old children and 22-year-old adults for 6 weeks and examined the effects using functional magnetic resonance imaging (fMRI). Both children and adults displayed better performance at the cognitive level, an effect that remained present for at least 6 months after the training program. In addition, the neuroimaging data before the training in children revealed an immature frontoparietal activation while executing the information manipulation task involving working memory. However, after the training, the differences in brain activation between children and adults decreased considerably.

As a whole, these results indicate that cognitive skills can be improved through training and that practice with exercises that engage the cognitive processes that we wish to improve can alter the functioning of the brain structures that underlie these processes, making them more efficient and bringing them closer to maturity.

Discussion and conclusions

Attention and self-regulation ability are essential for school learning. Optimizing and promoting the adequate development of children's attention must be one of the main objectives of educators and educational psychologists, since attentional problems constitute one of the main causes of academic failure. In order to achieve this important objective, it is essential to know the cognitive processes involved in attention and the way in that this capacity develops throughout infancy.

For decades, Cognitive Psychology has provided experimental tasks with which to measure and study the cognitive processes involved in attention and self-regulation. Aspects of activation, selection, and control have been linked to attentional capacity ever since the first theoretical models were created. In addition, the last decades have been witness to a spectacular degree of technological development in the field of neuroscience that allows us to examine the functioning of the brain in vivo and to study the cerebral basis of cognitive skills. Undoubtedly, attention is among the most extensively studied cognitive skills in the field of Cognitive Neuroscience. This has made it possible to establish the neuroanatomy of alerting, orienting, and executive control functions associated with attention. Knowing the cerebral basis of these elements is important, because this makes it possible to connect different levels of analysis of cognitive phenomena, from individual differences in attentional behavior observed in the classroom to genes that might be involved in these differences, along with the cognitive processes involved and knowledge of the brain structures that sustain them. Nowadays, all this knowledge is greatly useful for designing intervention programs that make it possible to train attention, thus improving behavior and cerebral functioning.

In this article, we have presented an approach based on cognitive neuroscience for the study of attention and its improvement through intervention strategies. New technologies allow us to study the direct effects of interventions on brain function. In this regard, we can state that it is possible to *educate the brain* through practice involving cognitive training exercises. More research is needed to optimize training programs and use them to prevent the development of pathologies associated with attention, as well as to alleviate their adverse effects on children's learning and socialization.

Original article received on March 20th, 2016

Article accepted on April 4th, 2016

References

- Abundis-Gutiérrez, A., Checa, P., Castellanos, C., & Rueda, M. R. (2014). Electrophysiological correlates of attention networks in childhood and early adulthood. *Neuropsychologia*, *57*, 78-92. doi: 10.1016/j.neuropsychologia.2014.02.013
- Anderson, P. (2002). Assessment and development of executive function (EF) during childhood. *Child Neuropsychology: A Journal on Normal and Abnormal Development in Childhood and Adolescence*, *8*(2), 71-82. doi: 10.1076/chin.8.2.71.8724
- Berger, A., Tzur, G., & Posner, M. I. (2006). Infant brains detect arithmetic errors. *Proceedings of the National Academy of Sciences of the United States of America*, *103*(33), 12649-12653. doi: 10.1073/pnas.0605350103
- Bernier, A., Carlson, S. M., & Whipple, N. (2010). From external regulation to self-regulation: Early parenting precursors of young children's executive functioning. *Child development*, *81*(1), 326-339. doi: 10.1111/j.1467-8624.2009.01397.x
- Bull, R., Espy, K. A., & Wiebe, S. A. (2008). Short-term memory, working memory, and executive functioning in preschoolers: longitudinal predictors of mathematical achievement at age 7 years. *Developmental Neuropsychology*, *33*(3), 205-228. doi: 10.1080/87565640801982312
- Checa, P., Rodriguez-Bailon, R., & Rueda, M. R. (2008). Neurocognitive and temperamental systems of self-regulation and early adolescents' school competence. *Mind, Brain and Education*, *2*(4), 177-187. doi: 10.1111/j.1751-228X.2008.00052.x
- Clearfield, M. W., & Jedd, K. E. (2013). The effects of socio-economic status on infant attention. *Infant and Child Development*, *22*(1), 53-67. doi:10.1002/icd.1770
- Colombo, J., & Horowitz, F. (1987). Behavioral state as a lead variable in neonatal research. *Merrill-Palmer Quarterly-Journal of Developmental Psychology*, *33*(4), 423-437. Retrieved from <http://www.jstor.org/stable/23086402>
- Congdon, E., Constable, R. T., Lesch, K. P., & Canli, T. (2009). Influence of SLC6A3 and COMT variation on neural activation during response inhibition. *Biological Psychology*, *81*(3), 144-152. doi: 10.1016/j.biopsycho.2009.03.005
- Congdon, E., Lesch, K. P., & Canli, T. (2008). Analysis of DRD4 and DAT Polymorphisms and Behavioral Inhibition in Healthy Adults: Implications for Impulsivity. *Am J Med Genet B*, *147*, 27-32. doi: 10.1002/ajmg.b.30557
- Courage, M. L., Reynolds, G. D., & Richards, J. E. (2006). Infants' attention to patterned stimuli: Developmental change from 3 to 12 months of age. *Child Development*, *77*(3), 680-695. doi: 10.1111/j.1467-8624.2006.00897.x
- Danis, A., Pecheux, M. -G., Lefevre, C., Bourdais, C., & Serres-Ruel, J. (2008). A continuous performance task in preschool children: Relations between attention and performance. *European Journal of Developmental Psychology*, *5*(4), 401-418. doi: 10.1080/17405620600866800
- Derryberry, D., & Rothbart, M. K. (1997). Reactive and effortful processes in the organization of temperament. *Development and Psychopathology*, *9*, 633-652.
- Diamond, A. (1990). The development and neural bases of higher cognitive functions. Introduction. In A. Diamond (Ed.), *Annals of the New York Academy of Sciences*, *608* (pp. xiii-lvi). New York: The New York Academy of Sciences. doi: 10.1111/j.1749-6632.1990.tb48888.x
- Diamond, A. (2006). The early development of executive functions. In E. Bialystok, & F. I. M. Craik (Eds.), *Lifespan cognition: Mechanisms of change* (pp. 70-95). New York: Oxford University Press.
- Diamond, A. (2013). Executive Functions. *Annual Review of Psychology*, *64*, 135-168. doi: 10.1146/annurev-psych-113011-143750
- Duncan, G. J., Dowsett, C. J., Claessens, A., Magnuson, K., Huston, A. C., Klebanov, P., Pagani, L., ...Japel, C. (2007). School readiness and later achievement. *Developmental Psychology*, *43*(6), 1428-1446. doi: 10.1037/0012-1649.43.6.1428.
- Duncan, G. J., Yeung, W. J., Brooks-Gunn, J., & Smith, J. R. (1998). How much does childhood poverty affect the life chances of children? *American Sociological Review*, *63*(3), 406-423. Retrieved from <http://www.jstor.org/stable/2657556>
- Eriksen, B. A., & Eriksen, C. W. (1974). Effects of noise letters upon the identification of a target letter in a non-search task. *Perception & Psychophysics*, *16*(1), 143-149. doi: 10.3758/BF03203267
- Fan, J., McCandliss, B. D., Fossella, J., Flombaum, J. I., & Posner, M. I. (2005). The activation of attentional networks. *Neuroimage*, *26*(2), 471-479.

- Fan, J., McCandliss, B. D., Sommer, T., Raz, A., & Posner, M. I. (2002). Testing the efficiency and independence of attentional networks. *Journal of Cognitive Neuroscience*, *14*(3), 340-347. doi: 10.1162/089892902317361886
- Fan, J., Wu, Y., Fossella, J. A., & Posner, M. I. (2001). Assessing the heritability of attentional networks. *BMC neuroscience*, *2*(14), 1-7. doi: 10.1186/1471-2202-2-14
- Gerardi-Caulton, G. (2000). Sensitivity to spatial conflict and the development of self-regulation in children 24-36 months of age. *Developmental Science*, *3*(4), 397-404. doi: 10.1111/1467-7687.00134
- Greenwood, P. M., Parasuraman, R., & Espeseth, T. (2012). A cognitive phenotype for a polymorphism in the nicotinic receptor gene CHRNA4. *Neurosci Biobehav Rev*, *36*, 1331-1341. doi: 10.1016/j.neubiorev.2012.02.010
- Holmboe, K., Fearon, R. M. P., Csibra, G., Tucker, L. A., & Johnson, M. H. (2008). Freeze-Frame: A new infant inhibition task and its relation to frontal cortex tasks during infancy and early childhood. *Journal of Experimental Child Psychology*, *100*(2), 89-114. doi: 10.1016/j.jecp.2007.09.004
- Hood, B. M. (1995). Shifts of visual attention in the infant: A neuroscientific approach. En L. L. C. Rovee-Collier (Ed.), *Advances in infancy research* (Vol. 9, pp. 163-216). Norwood, NJ: Ablex.
- Jaeggi, S. M., Buschkuhl, M., Jonides, J., & Shah, P. (2011). Short- and long-term benefits of cognitive training. *Proceedings of the National Academy of Sciences*, *108*(25), 10081-10086. doi: 10.1073/pnas.1103228108
- Jolles, D. D., Van Buchem, M. A., Rombouts, S. A. R. B., & Crone, E. A. (2012). Practice effects in the developing brain: A pilot study. *Developmental Cognitive Neuroscience*, *2*(Suppl. 1), S180-S191. doi: 10.1016/j.dcn.2011.09.001
- Johnson, M. H. (1994). Visual attention and the control of eye movements in early infancy. *Attention and Performance Vol. XV: Conscious and Unconscious Processing*, 291-310.
- Johnson, M. H., Posner, M., & Rothbart, M. (1991). Components of visual orienting in early infancy. Contingency learning, anticipatory looking, and disengaging. *Journal of Cognitive Neuroscience*, *3*(4), 335-344. doi: 10.1162/jocn.1991.3.4.335
- Johnson, M. H., & Tucker, L. A. (1996). The development and temporal dynamics of spatial orienting in infants. *Journal of Experimental Child Psychology*, *63*(1), 171-188. doi: 10.1006/jecp.1996.0046
- Karbach, J., & Kray, J. (2009). How useful is executive control training? Age differences in near and far transfer of task-switching training. *Developmental Science*, *12*(6), 978-990. doi: 10.1111/j.1467-7687.2009.00846.x
- Lawson, G. M., Duda, J. T., Avants, B. B., Wu, J., & Farah, M. J. (2013). Associations between children's socioeconomic status and prefrontal cortical thickness. *Developmental Science*, *16*(5), 641-652. doi: 10.1111/desc.12096
- Lin, C. C. H., Hsiao, C. K., & Chen, W. J. (1999). Development of sustained attention assessed using the continuous performance test among children 6-15 years of age. *Journal of Abnormal Child Psychology*, *27*(5), 403-412.
- Lipina, S. J., Martelli, M. I., Vuelta, B., & Colombo, J. A. (2005). Performance on the a-not-b task of Argentinean infants from unsatisfied and satisfied basic needs homes. *Revista Interamericana de Psicología*, *39*(1), 49-60.
- Marrocco, R. T., & Davidson, M. C. (1998). The neurochemistry of attention. In R. Parasuraman (Ed.), *The attentive brain* (pp. 35-50). Cambridge, MA: MIT Press.
- Mashburn, A. J., & Pianta, R. C. (2006). Social relationships and school readiness. *Early Education and Development*, *17*(1), 151-176. doi: 10.1207/s15566935eed1701_7
- Mezzacappa, E. (2004). Alerting, orienting, and executive attention: Developmental properties and sociodemographic correlates in an epidemiological sample of young, urban children. *Child Development*, *75*(5), 1373-1386. doi: 10.1111/j.1467-8624.2004.00746.x
- Millner, A. J., Jaroszewski, A. C., Chamarthi, H., & Pizzagalli, D. A. (2012). Behavioral and electrophysiological correlates of training-induced cognitive control improvements. *Neuroimage*, *63*(2), 742-753. doi: 10.1016/j.neuroimage.2012.07.032
- Miyake A., Friedman N. P., Emerson M. J., Witzki A. H., Howerter A., & Wager T. D. (2000). The unity and diversity of executive functions and their contributions to complex «frontal lobe» tasks: A latent variable analysis. *Cognitive Psychology*, *41*(1), 49-100. doi: 10.1006/cogp.1999.0734
- Monette, S., Bigras, M., & Guay, M. -C. (2011). The role of the executive functions in school achievement at the end of Grade 1. *Journal of Experimental Child Psychology*, *109*(2), 158-73. doi: 10.1016/j.jecp.2011.01.008

- Mueller, E. M., Makeig, S., Stemmler, G., Hennig, J., & Wacker, J. (2011). Dopamine effects on human error processing depend on catechol-O-methyltransferase VAL158MET genotype. *The Journal of Neuroscience*, 31(44), 15818-15825. doi: 10.1523/JNEUROSCI.2103-11.2011
- Noble, K. G., McCandliss, B. D., & Farah, M. J. (2007). Socioeconomic gradients predict individual differences in neurocognitive abilities. *Developmental Science*, 10(4), 464-480. doi: 10.1111/j.1467-7687.2007.00600.x
- Posner, M. I., Rothbart, M. K., & Sheese, B. E. (2007). Attention genes. *Developmental Science*, 10, 24-29. doi: 10.1111/j.1467-7687.2007.00559.x
- Pozuelos, J. P., Paz-Alonso, P. M., Castillo, A., Fuentes, L. J., & Rueda, M. R. (2014). Development of attention networks and their interactions in childhood. *Developmental psychology*, 50(10), 2405-2415. doi: 10.1037/a0037469
- Rothbart M. K. (2011). *Becoming who we are*. New York: Guilford.
- Rothbart, M. K., & Derryberry, D. (1981). Development of individual differences in temperament. In M. E. Lamb, & A. L. Brown (Eds.), *Advances in developmental psychology* (Vol. 1, pp. 37-86). Hillsdale, NJ: Erlbaum.
- Rueda, M. R., Checa, P., & Combita, L. M. (2012). Enhanced efficiency of the executive attention network after training in preschool children: Immediate and after two months effects. *Developmental Cognitive Neuroscience*, 2(1), 192-204. doi: 10.1016/j.dcn.2011.09.004
- Rueda, M. R., Checa, P., & Rothbart, M. K. (2010). Contributions of attentional control to socioemotional and academic development. *Early Education & Development*, 21(5), 744-764. doi: 10.1080/10409289.2010.510055
- Rueda, M. R., Fan, J., McCandliss, B. D., Halparin, J. D., Gruber, D. B., Lercari, L. P., & Posner, M. I. (2004). Development of attentional networks in childhood. *Neuropsychology*, 42(8), 1029-1040. doi: 10.1016/j.neuropsychologia.2003.12.012
- Rueda, M. R., Pozuelos, J. P., & Cómbita, L. M. (2015). Cognitive neuroscience of attention: From brain mechanisms to individual differences in efficiency. *AIMS Neuroscience*, 2(4), 183-202. doi: 10.3934/Neuroscience.2015.4.183
- Rueda, M. R., Rothbart, M. K., McCandliss, B. D., Saccomanno, L., & Posner, M. I. (2005). Training, maturation, and genetic influences on the development of executive attention. *Proceedings of the National Academy of Sciences of the USA*, 102, 14931-14936. doi: 10.1073/pnas.0506897102
- Rueda, M. R., & Posner, M. I. (2013). Development of attention networks. In P. D. Zelazo (Ed.), *The Oxford Handbook of Developmental Psychology, Vol. 1* (Chapter 24, pp. 683-705). United Kingdom: Oxford University Press. doi: 10.1093/oxfordhb/9780199958450.013.0024
- Ruff, H. A., & Lawson, K. R. (1990). Development of sustained, focused attention in young children during free play. *Developmental Psychology*, 26(1), 85. doi: 10.1037//0012-1649.26.1.85
- Ruff, H. A., & Rothbart, M. K. (1996). *Attention in early development: Themes and variations*. United Kingdom: Oxford University Press.
- Santesso, D. L., Segalowitz, S. J., & Schmidt, L. A. (2005). ERP correlates of error monitoring in 10-year-olds are related to socialization. *Biological Psychology*, 70(2), 79-87. doi: 10.1016/j.biopsycho.2004.12.004
- Schul, R., Townsend, J., & Stiles, J. (2003). The development of attentional orienting during the school-age years. *Developmental Science*, 6(3), 262-272. doi: 10.1111/1467-7687.00282
- Stevens, C., Lauinger, B., & Neville, H. (2009). Differences in the neural mechanisms of selective attention in children from different socioeconomic backgrounds: an event-related brain potential study. *Developmental Science*, 12(4), 634-646. doi: 10.1111/j.1467-7687.2009.00807.x
- Thorell, L. B., Lindqvist, S., Nutley, S. B., Bohlin, G., & Klingberg, T. (2009). Training and transfer effects of executive functions in preschool children. *Developmental Science*, 12(1), 106-113. doi: 10.1111/j.1467-7687.2008.00745.x
- Wainwright, A., & Bryson, S. E. (2005). The development of endogenous orienting: Control over the scope of attention and lateral asymmetries. *Developmental Neuropsychology*, 27(2), 237-255. doi: 10.1207/s15326942dn2702_3
- Yeniad, N., Malda, M., Mesman, J., van IJzendoorn, M. H., & Pieper, S. (2013). Shifting ability predicts math and reading performance in children: A meta-analytical study. *Learning and Individual Differences*, 23, 1-9. doi: 10.1016/j.lindif.2012.10.004

